

#319
SHW BALANCE ROD FOOT

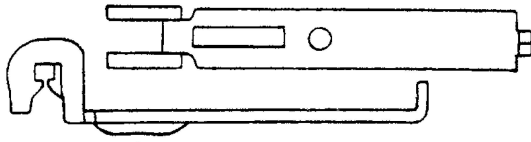

#10663
NYLON CLAD S.H. METAL FOOT



#1123
3/8" BALANCE FOOT

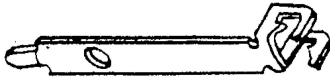

#317
KELLER BALANCE CAP



#1017
ROUND BALANCE
ROD CAP



#340
P.G.T. END SET

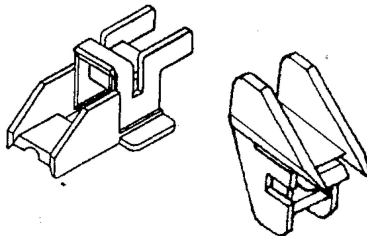

#349
PAN AM BAL ROD END SET

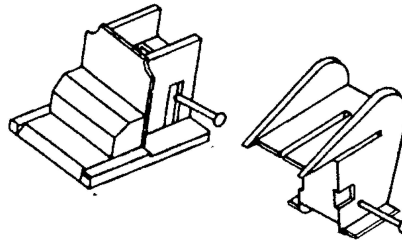

#351
OLD SECURITY, JONES

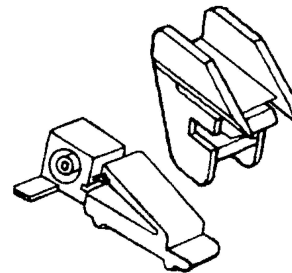

#352
YALE OGRON

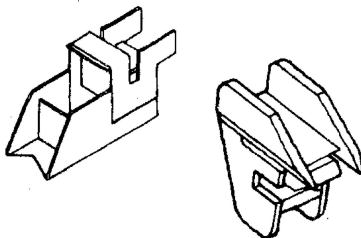

#353
KINCO, CLEARVIEW, NU AIR /HARCAR

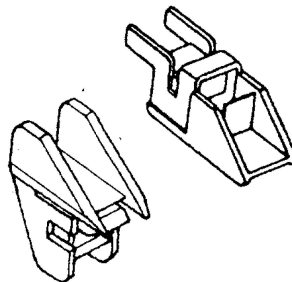

#350
GEORGIA/PALM BEACH
TOP FOOT

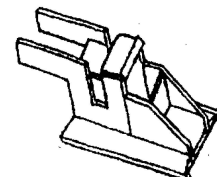

#358
AIRELOCK GUIDE

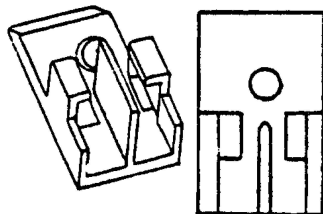

#359
AIRELOCK SHW ROD FOOT

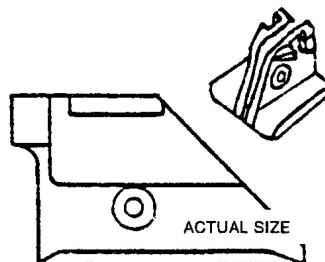

#510
AIR CONTROL S.H. NYLON SHOE

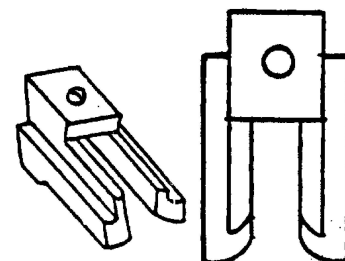

#1012
STANLEY SH FT. W/PLASTIC BASE

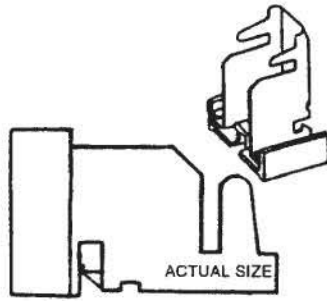

#1014
TUCKER S.H. METAL &
PLASTIC SHOE

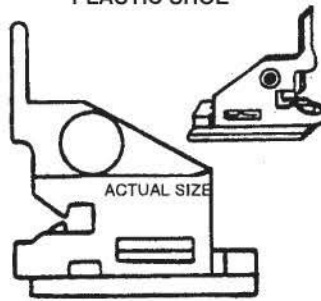

#1016
ABC/HARCAR METAL SHOE

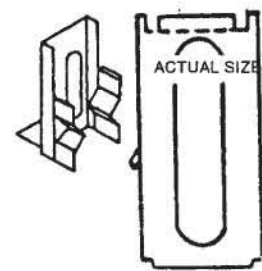

#1034
ABC BALANCE FT.

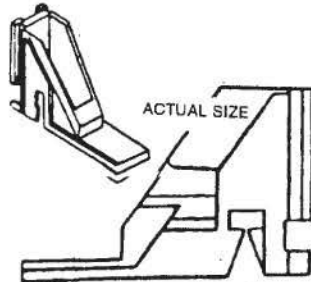

#1037
STANLEY TUCKER FOOT

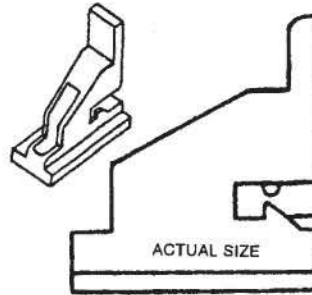

#1040
CROSSLY #780

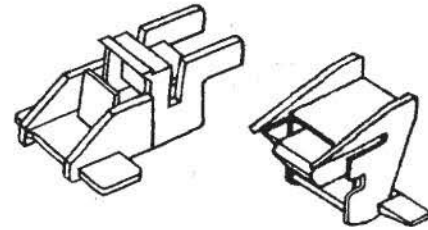

#1041
A.C. SMALL SH PLASTIC FOOT

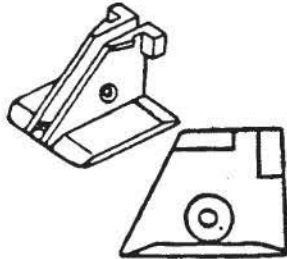

#1042
CROSSLY #700

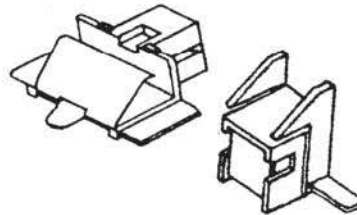

#1111
C.E., MILLER, ANDERSON/ALCAN

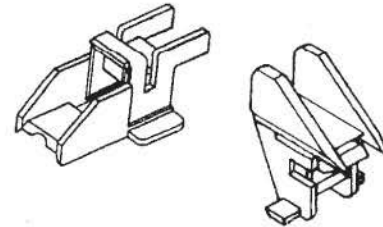

#1116
LOOK METAL RD BAL FOOT



#1208
OLD PAN AM BAL/ROD FOOT

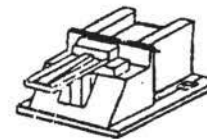
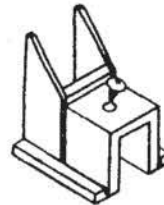

#10197
C.E./MILLER TOP FOOT

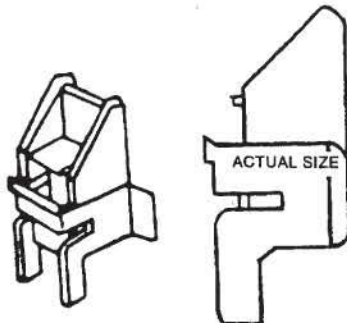

#10239
OLD PAN AM S.H. BOTTOM FOOT

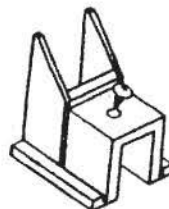

#10240
OLD PAN AM S.H. TOP FOOT

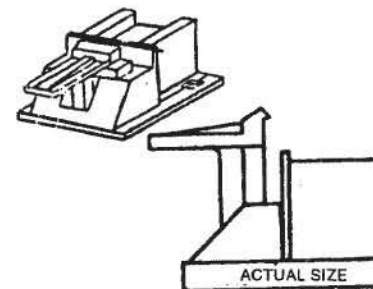

Balance Rod Ends

www.bartonkramer.com

#10301
KELLER INTERMEDIATE

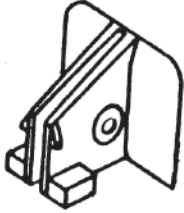

#10327
YALE TOP FOOT

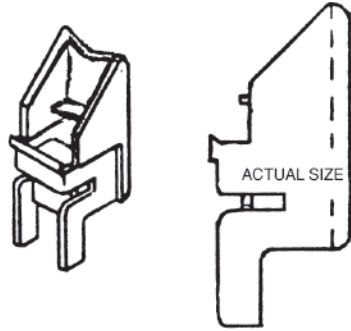

#10328
SECURITY/YALE/KINCO
BOTTOM FOOT

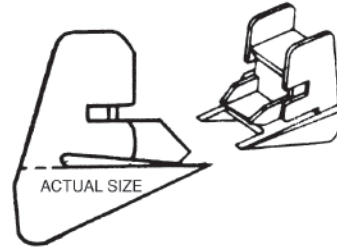

#10329
OLD SECURITY-JONES TOP FOOT

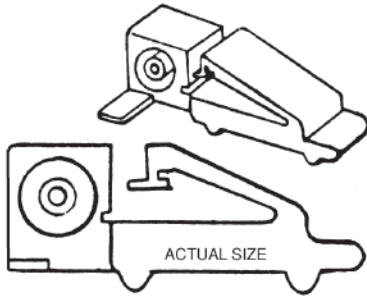

#10410
PAN AM TOP FOOT

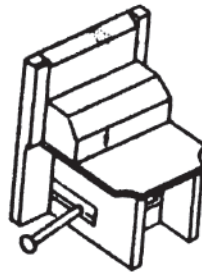

#10411
PAN AM BOTTOM FOOT

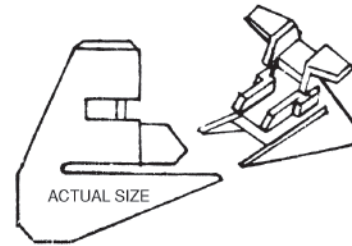

#10412
KINCO TOP FOOT

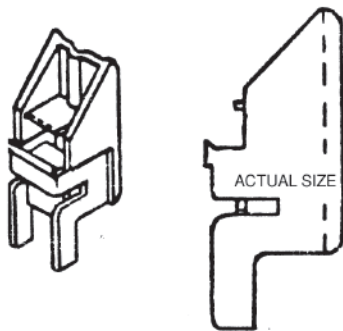

#10554
NEW SECURITY TOP FOOT

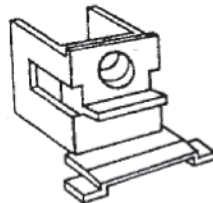

#1212
TRACO ENDS SET
IMPACT

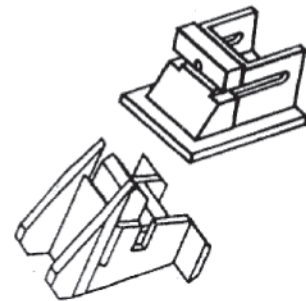

#10625
CAPITAL TOP FOOT

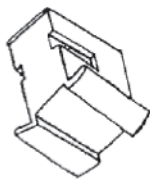

#360
NEW SECURITY ENDS SET

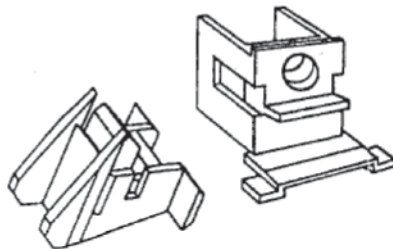

#10725
TRACO TOP FOOT IMPACT

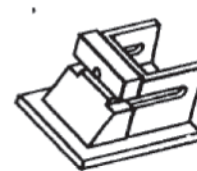

#10664
S.H. FOOT WITH METAL HOOK

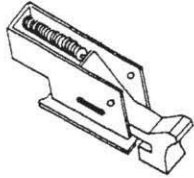

#10665
SILVERLINE TOP S.H. FOOT



#10666
SILVERLINE BOTTOM FOOT

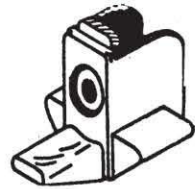

#354
BALANCE ROD RIVET
5/8" LENGTH



#10247
SMALL RIVET
FOR AIRE-LOK
11/32" Length



#363
ROLLYSON

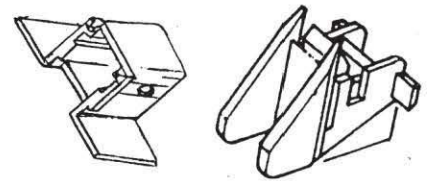

#10760
FOR KELLER
3/32" X 9/32"

#10743
CROSSLY BOTTOM FOOT
(FOR #1040)

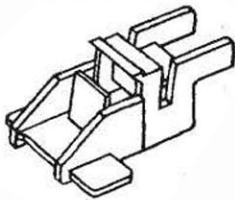

#10742
CROSSLY TOP FOOT
(FOR #1040)



#365
METAL SHW TAKE OUT CLIP

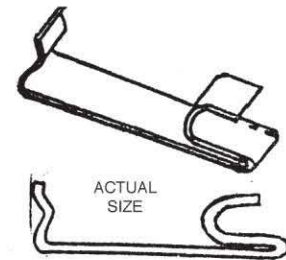

#344
SHW BAL ROD WINDER TOOL

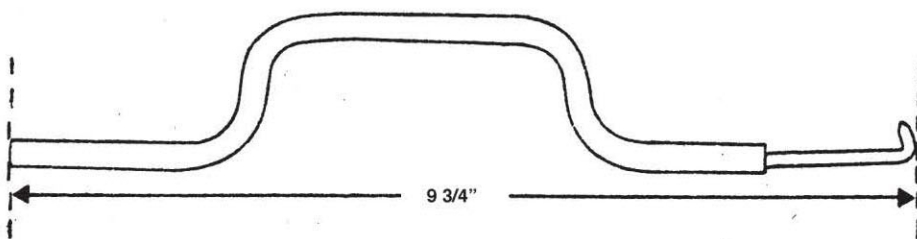

#10744
WIRE WINDER TOOL

