

#905
PAN AM - PAIRS

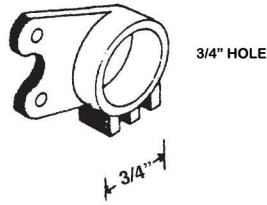

#906
TUCKER

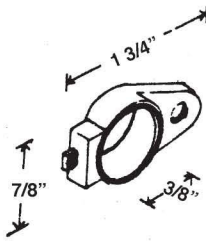

#907
SUPERIOR

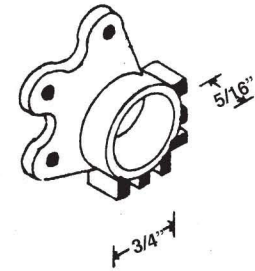

#910
KELLER - AIR CONTROL

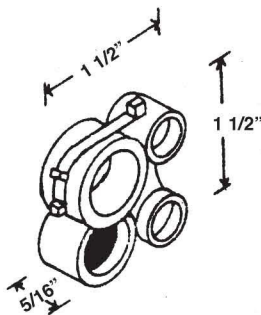

#911
AIR CONTROL #2



#912
TORQUE BEARING

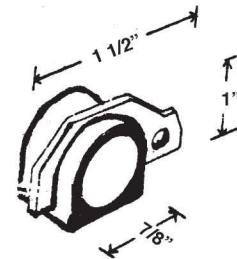

#913
P.G.T.

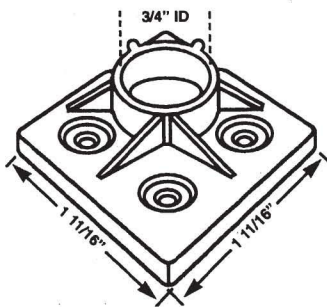

#915
AIRE LOK

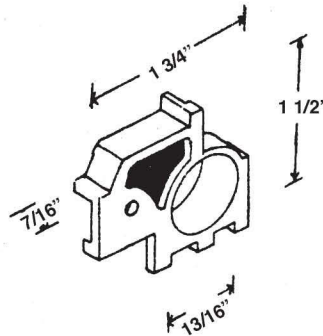

#916
LOOK - OLD

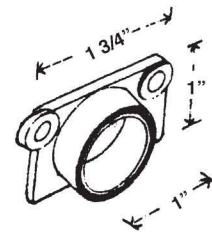

#917
YALE OGRON

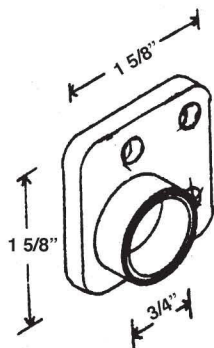

#921
CE - STANLEY

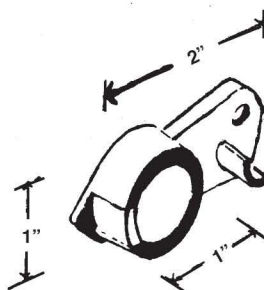

#922
HARCAR - NEW - PAIRS

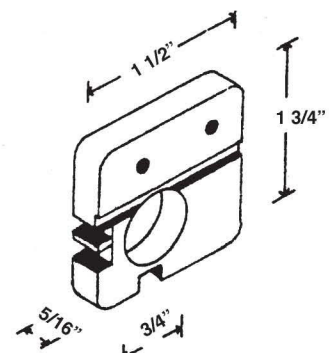

#934
TUCKER - PAIRS

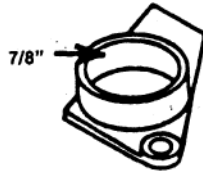

#931
HARCAR - OLD

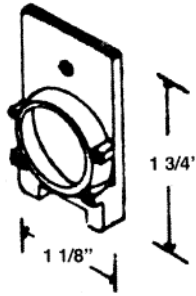

#932
LOOK - NEW

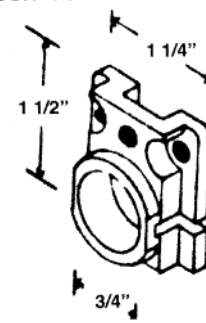

Bolts, Bushings, E-Rings, Screws

#181
OPERATOR MOUNTING
NUT & BOLT
10-24 X 5/8"

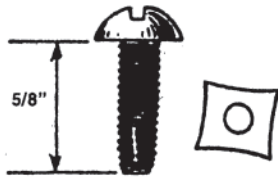

#182
OPERATOR MOUNTING SCREWS
10 X 5/8"

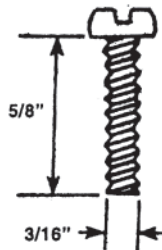

#187
OVERSIZE MOUNTING
SCREWS
12 X 5/8"



#10057 SHEET METAL SCREW

#188
JALOUSIE CLIP RIVET



#199
JALOUSIE REPAIR RIVET
FOR LINK

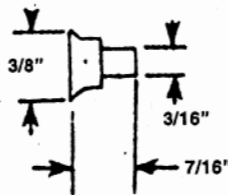

#10241
ABC CONTROL RIVET

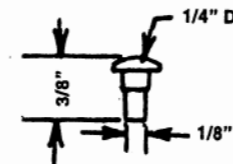

#190
A.C. SHOULDER BOLT

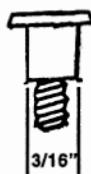

#191
SHOULDER BOLT & BUSHING
KELLER

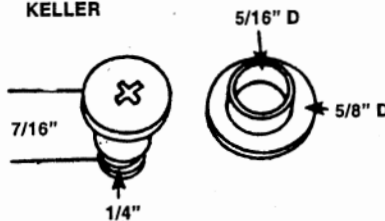

#192
SHOULDER BOLT & BUSHING

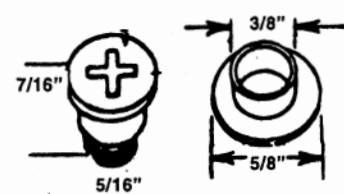

IF YOU DON'T SEE IT, CALL US; WE PROBABLY HAVE IT!!!